

Technical data sheet

Locknut, metric thread, light grey

Item number: 2048957



Locknut DIN 46319, with metric thread IEC 423.



PA Polyamide

Master data

Item number	2048957
Description 1	Locknut
Manufacturer	OBO
Dimension	M40
Colour	Light grey; RAL 7035
Material	Polyamide
Smallest sales unit	25
Unit of quantity	Piece
Weight	1.683 kg
Weight unit	kg/100 pc.
CO Footprint (GWP) Cradle-to-Gate	0,0387 kg COe / 1 Piece

Technical data sheet

Locknut, metric thread, light grey

Item number: 2048957



Dimensions



Dimension E	56 mm
Dimension L	7 mm

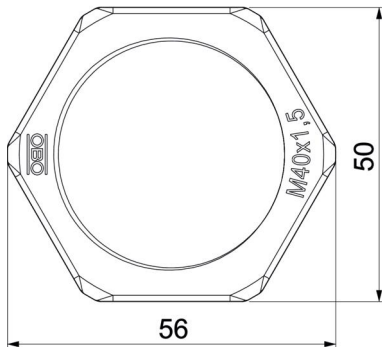

Technical data

Thread	M40_x_1,5
Thread type	Metric
Nominal thread size metric/PG	40
Fibre-glass reinforced	no
Halogen-free	yes
Impact-resistant	no
WAF	50