

Technical data sheet

Locknut, metric thread, silver grey

Item number: 2048809



Locknut to DIN 46319, with metric thread IEC 423.



PA Polyamide

Master data

Item number	2048809
Type	116 M40 SGR PA
Description 1	Locknut
Manufacturer	OBO
Dimension	M40
Colour	Silver grey; RAL 7001
Material	Polyamide
Smallest sales unit	25
Unit of quantity	Piece
Weight	0.602 kg
Weight unit	kg/100 pc.
CO2 Footprint (GWP) Cradle-to-Gate	0,0309 kg CO2e / 1 Piece

Technical data sheet

Locknut, metric thread, silver grey

Item number: 2048809



Dimensions



Dimension E	56 mm
Dimension L	7 mm

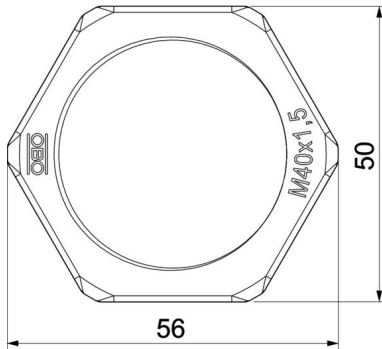

Technical data

Thread	M40 x 1,5
Thread type	Metric
Nominal thread size metric/PG	40
Fibre-glass reinforced	no
Halogen-free	yes
Impact-resistant	no
WAF	50