

Technical data sheet

Locknut, metric thread

Item number: 2049570



Locknut to DIN 46319, with metric thread IEC 423.

Note: Only tighten polystyrene cable glands lightly due to the risk of stress crack formation.



PS Polystyrene

Master data

Item number	2049570
Type	116 M50 LGR PS
Description 1	Locknut
Manufacturer	OBO
Dimension	M50
Colour	Light grey; RAL 7035
Material	Polystyrene
Smallest sales unit	25
Unit of quantity	Piece
Weight	0.732 kg
Weight unit	kg/100 pc.
CO2 Footprint (GWP) Cradle-to-Gate	0,0336 kg CO2e / 1 Piece

Technical data sheet

Locknut, metric thread

Item number: 2049570



Dimensions



Dimension E	68 mm
Dimension L	8 mm

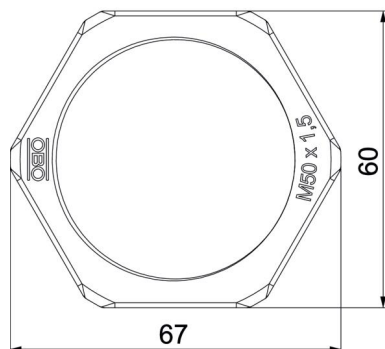

Technical data

Thread	M50 x 1,5
Thread type	Metric
Nominal thread size metric/PG	50
Fibre-glass reinforced	no
Halogen-free	yes
Impact-resistant	yes
WAF	60