

Technical data sheet

Pipe end cap, metric, black

Item number: 2047950



Pipe end sleeve to slot onto electrical installation pipes, metric.



PE Polyethylene

Master data

Item number	2047950
Type	129 M25 SW
Description 1	Pipe end sleeve
Description 2	metric
Manufacturer	OBO
Dimension	M25
Colour	Black
Material	Polyethylene
Smallest sales unit	50
Unit of quantity	Piece
Weight	0.235 kg
Weight unit	kg/100 pc.

Technical data sheet

Pipe end cap, metric, black

Item number: 2047950



Dimensions

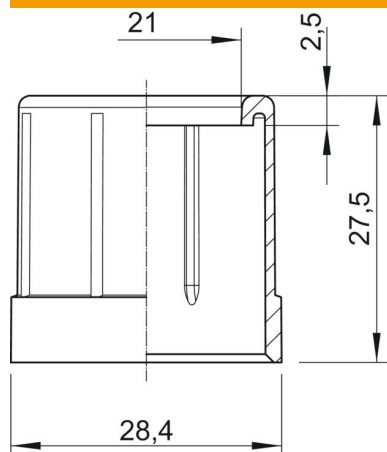

Dimension D1	28.4 mm
Dimension D2	21 mm
Dimension L1	27.5 mm
Dimension L2	2.5 mm

Technical data

Version for for pipe diameter	Connector 25 mm
Size	M25
Halogen-free	yes
Brushed surface	no
Polished surface	no