

Technical data sheet

ISO nail clip 2004, light grey

Item number: 2227231



ISO nail clip, short design



PP Polypropylene

Master data

Item number	2227231
Type	2004 25 LGR
Description 1	ISO nail clip
Manufacturer	OBO
Dimension	4mm, L25
Colour	Light grey; RAL 7035
Material	Polypropylene
Smallest sales unit	200
Unit of quantity	Piece
Weight	0.071 kg
Weight unit	kg/100 pc.
CO2 Footprint (GWP) Cradle-to-Gate	0,0022 kg CO2e / 1 Piece

Technical data sheet

ISO nail clip 2004, light grey



Item number: 2227231

Dimensions

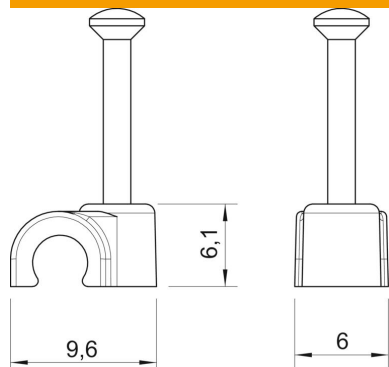

Dimension B	6 mm
Dimension H	6.1 mm
Dimension L	9.6 mm

Technical data

Double clip	no
Shape for cable diameter	Round (for round conductor)
For nail diameter	4 mm
For nail diameter	2,0x25
Hardened	yes
Halogen-free	yes
With nail	yes
Nail length	25 mm
Impact-resistant	no
Transparent	no
Pipe locking	no