

Technical data sheet

ISO nail clip 2008, light grey

Item number: 2232814



ISO nail clip, short design



PP Polypropylene

Master data

Item number	2232814
Type	2008 35 LGR SO
Description 1	ISO nail clip
Manufacturer	OBO
Dimension	8mm, L35
Colour	Light grey; RAL 7035
Material	Polypropylene
Smallest sales unit	300
Unit of quantity	Piece
Weight	0.127 kg
Weight unit	kg/100 pc.
CO2 Footprint (GWP) Cradle-to-Gate	0,0037 kg CO2e / 1 Piece

Technical data sheet

ISO nail clip 2008, light grey

Item number: 2232814

Dimensions

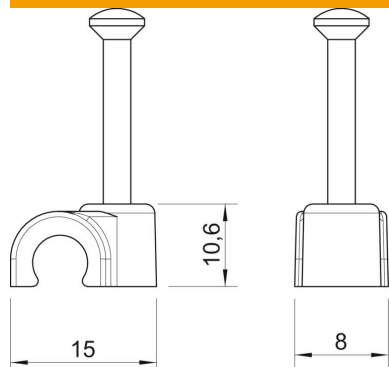

Dimension B	8 mm
Dimension H	10.6 mm
Dimension L	15 mm

Technical data

Double clip	no
Shape for cable diameter	Round (for round conductor)
For nail diameter	8 mm
For nail diameter	2,0x25
Hardened	yes
Halogen-free	yes
With nail	yes
Nail length	35 mm
Impact-resistant	no
Transparent	no
Pipe locking	no