

Technical data sheet

ISO nail clip 2012, white

Item number: 2226022



ISO nail clip, short design



PP Polypropylene

Master data

Item number	2226022
Type	2012 35 RW
Description 1	ISO nail clip
Manufacturer	OBO
Dimension	12mm, L35
Colour	Pure white; RAL 9010
Material	Polypropylene
Smallest sales unit	100
Unit of quantity	Piece
Weight	0.169 kg
Weight unit	kg/100 pc.
CO2 Footprint (GWP) Cradle-to-Gate	0,006 kg CO2e / 1 Piece

Technical data sheet

ISO nail clip 2012, white

Item number: 2226022



Dimensions

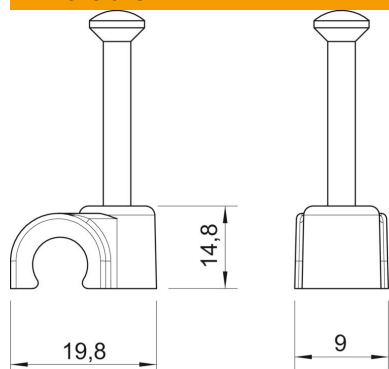

Dimension B	9 mm
Dimension H	14.8 mm
Dimension L	19.8 mm

Technical data

Double clip	no
Shape for cable diameter	Round (for round conductor)
For nail diameter	2,0x35
Hardened	yes
Halogen-free	yes
With nail	yes
Nail length	35 mm
Impact-resistant	no
Pipe locking	no