

Technical data sheet

Lightning ISO clip, screw-on

Item number: 2158345

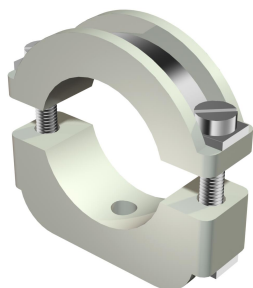

Lightning ISO clips: plastic clip with metal insert, therefore also suitable for heavy-duty applications; metal parts made of electrogalvanised steel.
Can be screwed onto M6 thread.
*Sizes 6–12 and 10–17 not suitable for bolt-firing device.



PS Polystyrene

Master data

Item number	2158345
Type	3022 LGR
Description 1	Lightning ISO clip
Manufacturer	OBO
Dimension	24-34mm
Colour	Light grey; RAL 7035
Material	Polystyrene
Smallest sales unit	25
Unit of quantity	Piece
Weight	3.623 kg
Weight unit	kg/100 pc.
CO2 Footprint (GWP) Cradle-to-Gate	0,1288 kg CO2e / 1 Piece

Technical data sheet

Lightning ISO clip, screw-on

Item number: 2158345

Dimensions

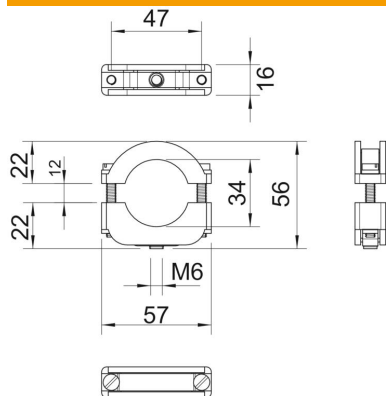

Dimension A	57 mm
Dimension B	47 mm
Dimension b	16 mm
Dimension D	34 mm
Dimension H	56 mm
Dimension Ho (mm)	22
Dimension Hu (mm)	22
Dimension l	35 mm
Dimension x	10 mm

Technical data

Number of cables/pipes	1
Version for	Closed
Fastening type	Threaded connection
Suitable in fire protection area	no
Halogen-free	yes
Plastic-covered	no
Bolt	M5 x 35
Clamping range D, max.	34 mm
Clamping range D, min.	24 mm
UV-resistant	no