

Technical data sheet

Wall and support bracket AW 55 A2

Item number: 6443067



Heavy-duty wall and support bracket with welded head plate.
Fastening of the bracket to the U support of width 400 mm or greater using a hexagonal bolt through both sides of the support. Please insert suitable spacers.



A2 Stainless steel

2B Bright, treated

Master data

Item number	6443067
Type	AW 55 31 A2
Description 1	Wall and support bracket
Description 2	with welded head plate
Manufacturer	OBO
Dimension	B310mm
Colour	stainless steel
Material	Stainless steel 1.4301
Surface	Bright, treated
Surface standard	
Smallest sales unit	1
Unit of quantity	Piece
Weight	118.9 kg
Weight unit	kg/100 pc.
CO2 Footprint (GWP) Cradle-to-Gate	6,7905 kg CO2e / 1 Piece

Technical data sheet

Wall and support bracket AW 55 A2

Item number: 6443067



Dimensions

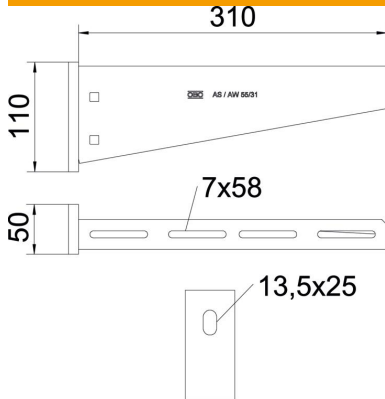

Length	50 mm
Width	310 mm
Height	110 mm
Dimension A	50 mm
Dimension B	310 mm
Dimension H	110 mm

Technical data

Version for	Wall and support bracket
F in kN	5.5 kN
Maintain electrical functions	no
Hole diameter	13.5 mm
Rustproof steel, pickled	yes
Angle range, max.	90 mm
Angle range, min.	90 mm

Loads

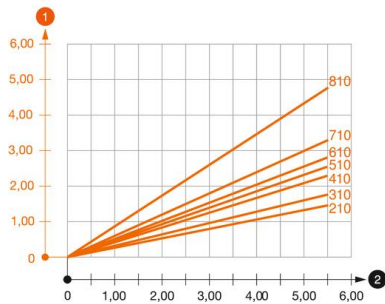

Load diagram, bracket, type AW 55

- 1 Bending of the bracket tip at permitted bracket load
- 2 Permitted bracket load in kN without man load
- Load curve with bracket lengths in mm

Technical data sheet

Wall and support bracket AW 55 A2

Item number: 6443067



Characteristic anchor load values for wall and support bracket AW 55

Wall fastening	Max. load [kN]
	Bracket width [mm]
Anchor type	<TEXT><P>210</P></TEXT>, <TEXT><P>310</P></TEXT>, <TEXT><P>410</P></TEXT>, <TEXT><P>510</P></TEXT>, <TEXT><P>560</P></TEXT>, <TEXT><P>610</P></TEXT>, <TEXT><P>710</P></TEXT>, <TEXT><P>810</P></TEXT>, <TEXT><P>910</P></TEXT>, <TEXT><P>1010</P></TEXT>
BZ3 12x110/0-35	<TEXT><P>3.92</P></TEXT>, <TEXT><P>3.83</P></TEXT>, <TEXT><P>3.79</P></TEXT>, <TEXT><P>3.46</P></TEXT>, <TEXT><P>3.30</P></TEXT>, <TEXT><P>3.30</P></TEXT>, <TEXT><P>3.15</P></TEXT>, <TEXT><P>2.53</P></TEXT>, <TEXT><P>2.38</P></TEXT>, <TEXT><P>2.23</P></TEXT>

Max. Belastung F ges. = Kabelgewicht + Kabelrinne + Ausleger. Die angegebenen Werte basieren auf gerissenem Beton der Festigkeitsklasse C20/25. Die Einbaubedingungen der ETA-Zulassung (Dübel) sind zu beachten!