

Technical data sheet

Pipe bend, plastic, halogen-free

Item number: 2047738



Accessory part: 90° bend to EN 61386 (Code: 4421) for halogen-free electrical installation pipes.



PC/
ABS

Polycarbonate/Acrylnitrile-butadiene-styrene

Master data

Item number	2047738
Type	KBH20 LGR
Description 1	Plastic armoured pipe bend
Description 2	halogen-free
Manufacturer	OBO
Dimension	Ø20mm
Colour	Light grey; RAL 7035
Material	Polycarbonate/Acrylnitrile-butadiene-styrene
Smallest sales unit	25
Unit of quantity	Piece
Weight	3.2 kg
Weight unit	kg/100 pc.

Technical data sheet

Pipe bend, plastic, halogen-free

Item number: 2047738



Dimensions

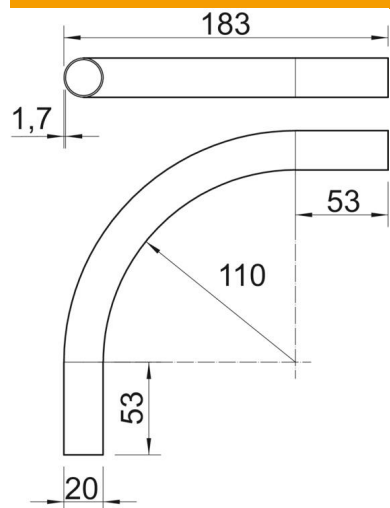

Length	183 mm
Dimension A	53 mm
Dimension D	20 mm
Dimension L	183 mm
Dimension m (mm)	M20
Dimension R	110 mm
Dimension t	1.7 mm

Technical data

Version for	Connector
Flexible	no
For nominal pipe diameter	20 mm
Halogen-free	yes
With sleeve	no
Angle of the bend	90 °