

Technical data sheet

Pipe bend, plastic, halogen-free

Item number: 2047739



Accessory part: 90° bend to EN 61386 (Code: 4421) for halogen-free electrical installation pipes.



PC/
ABS

Polycarbonate/Acrylnitrile-butadiene-styrene

Master data

Item number	2047739
Type	KBH25 LGR
Description 1	Plastic armoured pipe bend
Description 2	halogen-free
Manufacturer	OBO
Dimension	Ø25mm
Colour	Light grey; RAL 7035
Material	Polycarbonate/Acrylnitrile-butadiene-styrene
Smallest sales unit	25
Unit of quantity	Piece
Weight	4.9 kg
Weight unit	kg/100 pc.

Technical data sheet

Pipe bend, plastic, halogen-free

Item number: 2047739



Dimensions

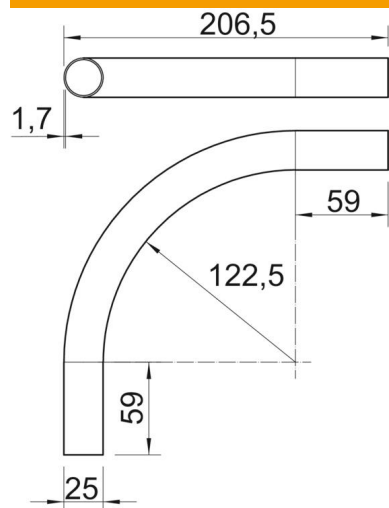

Length	206.5 mm
Dimension A	59 mm
Dimension D	25 mm
Dimension L	206.5 mm
Dimension m (mm)	M25
Dimension R	122.5 mm
Dimension t	1.7 mm

Technical data

Version for	Connector
Flexible	no
For nominal pipe diameter	25 mm
Halogen-free	yes
With sleeve	no
Angle of the bend	90 °