

# Technical data sheet

## Pipe bend, plastic, halogen-free

Item number: 2047741



Accessory part: 90° bend to EN 61386 (Code: 4421) for halogen-free electrical installation pipes.



PC/  
ABS

Polycarbonate/Acrylnitrile-butadiene-styrene

### Master data

|                     |  |
|---------------------|--|
| Item number         | 2047741                                      |
| Type                | KBH40 LGR                                    |
| Description 1       | Plastic armoured pipe bend                   |
| Description 2       | halogen-free                                 |
| Manufacturer        | OBO  |
| Dimension           | Ø40mm  |
| Colour              | Light grey; RAL 7035                         |
| Material            | Polycarbonate/Acrylnitrile-butadiene-styrene |
| Smallest sales unit | 10   |
| Unit of quantity    | Piece  |
| Weight              | 12.4 kg                                      |
| Weight unit         | kg/100 pc.                                   |

# Technical data sheet

Pipe bend, plastic, halogen-free

Item number: 2047741



## Dimensions

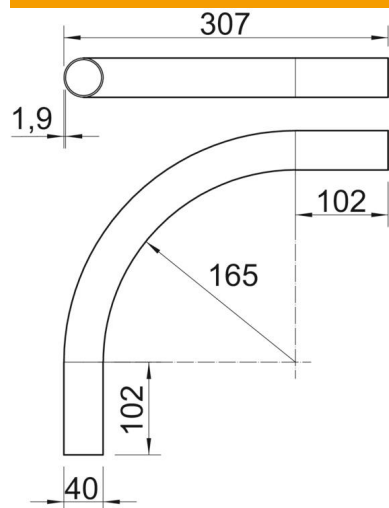

|                  |        |
|------------------|--------|
| Length           | 307 mm |
| Dimension A      | 102 mm |
| Dimension D      | 40 mm  |
| Dimension L      | 307 mm |
| Dimension m (mm) | M40    |
| Dimension R      | 165 mm |
| Dimension t      | 1.9 mm |

## Technical data

|                           |           |
|---------------------------|-----------|
| Version for               | Connector |
| Flexible                  | no        |
| For nominal pipe diameter | 40 mm     |
| Halogen-free              | yes       |
| With sleeve               | no        |
| Angle of the bend         | 90 °      |