

# Technical data sheet

Edge protection ring KSR 20030, for LKM cable duct type  
LKM 20030

Item number: 6249844



Edge protection ring for the open ends of LKM cable trunking.



**PVC** Polyvinylchloride

## Master data

Item number	6249844
Type	KSR20030
Description 1	Edge protection ring
Description 2	for LKM trunking
Manufacturer	OBO
Dimension	20x30mm
Colour	Grey
Material	Polyvinylchloride
Smallest sales unit	5
Unit of quantity	Piece
Weight	1.1 kg
Weight unit	kg/100 pc.

# Technical data sheet

Edge protection ring KSR 20030, for LKM cable duct type  
LKM 20030

Item number: 6249844



## Dimensions

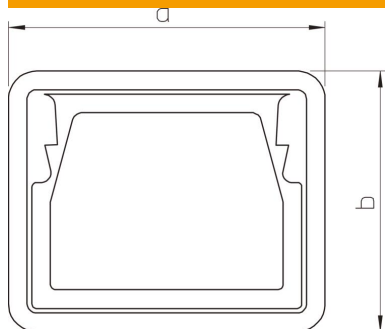

Length	23 mm
Width	34 mm
Height	28 mm
Dimension a	34 mm
Dimension b	28 mm

## Technical data

Type	Injection-moulded part
Suitable for	Cable routing duct
Halogen-free	yes
Protection rating	IP30
Protection rating IK code	IK10
Permitted temperature range, max.	90 °C
Permitted temperature range, min.	-5 °C