

Technical data sheet

Edge protection ring KSR 40040, for LKM cable trunking type LKM 40040

Item number: 6249846



Edge protection ring for the open ends of LKM cable trunking.



PVC Polyvinylchloride

Master data

Item number	6249846
Type	KSR40040
Description 1	Edge protection ring
Description 2	for LKM trunking
Manufacturer	OBO
Dimension	40x40mm
Colour	Grey
Material	Polyvinylchloride
Smallest sales unit	5
Unit of quantity	Piece
Weight	1.8 kg
Weight unit	kg/100 pc.

Technical data sheet

Edge protection ring KSR 40040, for LKM cable trunking type LKM 40040

Item number: 6249846



Dimensions

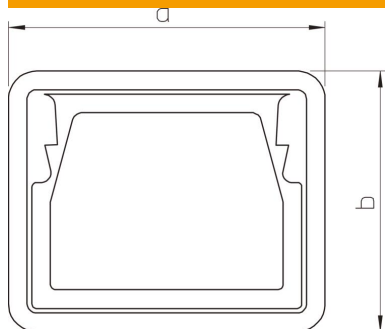

Length	21 mm
Width	44 mm
Height	48 mm
Dimension a	44 mm
Dimension b	48 mm

Technical data

Type	Injection-moulded part
Suitable for	Cable routing duct
Halogen-free	yes
Protection rating	IP30
Protection rating IK code	IK10
Permitted temperature range, max.	90 °C
Permitted temperature range, min.	-5 °C