

# Technical data sheet

Cover for 90° bend FT

Item number: 6226010



Cover with turn buckles for covering 90° cable ladder bends with welded rungs.

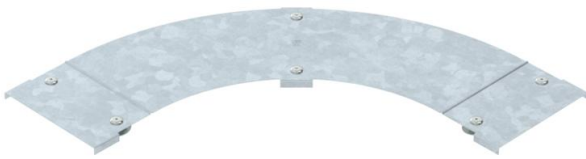

**St** Steel

**FT** Hot-dip galvanised

## Master data

Item number	6226010
Type	LBD 90 200 R3 FT
Description 1	90° bend cover
Description 2	with turn buckle
Manufacturer	OBO
Dimension	B200
Colour	zinc
Material	Steel
Surface	Hot-dip galvanised
Surface standard	DIN EN ISO 1461
Smallest sales unit	1
Unit of quantity	Piece
Weight	158 kg
Weight unit	kg/100 pc.
CO2 Footprint (GWP) Cradle-to-Gate	6,4812 kg CO2e / 1 Piece

# Technical data sheet

## Cover for 90° bend FT

Item number: 6226010



### Dimensions

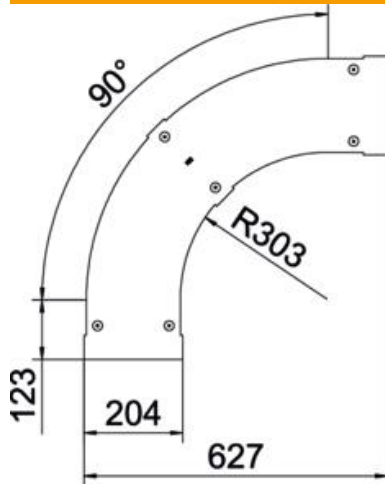

Width	200 mm
Plate thickness	1 mm
Dimension B	200 mm

### Technical data

Bend (angle)	90°
Fastening type	Sash lock
Maintain electrical functions	no
Suitable for mesh cable tray	no
Suitable for cable ladder	yes
Suitable for cable tray	no
Change of direction	Horizontal
Rustproof steel, pickled	no
Hinged	no