

Technical data sheet

Cable duct, type LKM 30030

Item number: 6248489



Duct cover and base with base perforation.
Equipotential bonding is guaranteed between the cover and the base without any additional aids.



- St** Steel
- FSK** Strip galvanized / plastic coated

Master data

Item number	6248489
Type	LKM30030RW
Description 1	Cable trunking
Description 2	with base perforation
Manufacturer	OBO
Dimension	30x30x2000
Colour	Pure white; RAL 9010
Material	Steel
Surface	Strip galvanized / plastic coated
Surface standard	DIN EN 10346
Smallest sales unit	2
Unit of quantity	Metre
Weight	66.5 kg
Weight unit	kg/100 m
CO2 Footprint (GWP) Cradle-to-Gate	1,4362 kg CO2e / 1 Meter

Technical data sheet

Cable duct, type LKM 30030

Item number: 6248489

Dimensions

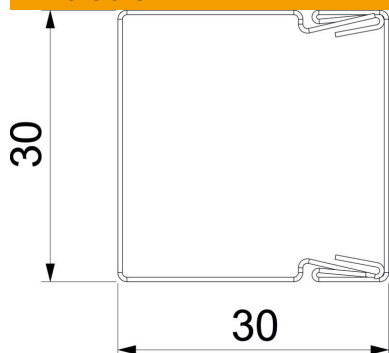

Length	2,000 mm
Width	30 mm
Height	30 mm

Technical data

Number of fixed partitions	0
Number of cables NYM 3 x 1.5 mm ² Ø 10.5 mm (without socket)	4
Number of cables NYM 3 x 2.5 mm ² Ø 11.5 mm (without socket)	4
Number of cables NYM 5 x 1.5 mm ² Ø 12.0 mm (without socket)	4
Number of insertable partitions	0
Version, cable trunking cover	Loose
Fastening type	Base perforation
Base perforation	with base perforation
Maintain electrical functions	no
Halogen-free	yes
Cable retaining clip	no
Duct connector	no
Delivery on a roll	no
Usable cross-section	805 mm ²
Protection rating	IP30
Protective film	no
Protection rating IK code	IK10
Permitted temperature range, max.	90 °C
Permitted temperature range, min.	-5 °C
Transparent	no