

Technical data sheet

Height-adjustable heavy-duty cassette for tube body RK-FRSL, nominal size R4, stainless steel
Item number: 7409464



Round heavy-duty cassette for tube body of nominal size R4 for the installation of accessories in trunking systems, raised and cavity floors, in dry or wet-cleaned floors indoors. Load class 2 to 20 kN.

Height-adjustable heavy-duty cassette with tube body with a load bearing capacity of 2-20 kN, 2-compartment. 2 APMT2 cover plates can be installed. For the installation of two UT3 universal supports for four single accessories with support ring/support clamp or six Modul 45 devices. The tube body is not contained in the scope of delivery.



A2 Stainless steel

Master data

| | |
|------------------------------------|---------------------------|
| Item number | 7409464 |
| Type | RKFR2 4 SL2V2 25 |
| Description 1 | Heavy-duty cassette |
| Description 2 | for tube, 20 kN |
| Manufacturer | OBO |
| Dimension | Ø215mm |
| Material | Stainless steel 1.4301 |
| Smallest sales unit | 1 |
| Unit of quantity | Piece |
| Weight | 669 kg |
| Weight unit | kg/100 pc. |
| CO2 Footprint (GWP) Cradle-to-Gate | 14,9296 kg CO2e / 1 Piece |

Technical data sheet

Height-adjustable heavy-duty cassette for tube body RK-FRSL, nominal size R4, stainless steel
Item number: 7409464



Dimensions

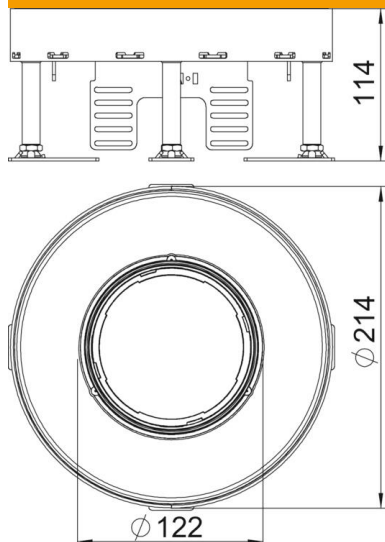

| | |
|-------------|--------|
| Dimension h | 114 mm |
|-------------|--------|

Technical data

| | |
|--|---------------------|
| Number of installable devices | 6 |
| Number of mounting boxes | 2 |
| Number of cable outlets | 1 |
| Version for | Round |
| Cable outlet version | Lowerable tube body |
| Floor care | Wet |
| Decouplable | no |
| Floor height, max. | 159 mm |
| Floor height, min. | 114 mm |
| Suitable for raised floor installation | yes |
| Suitable for cavity floor installation | yes |
| Suitable for underfloor box | 250/350 |
| Device support to accept mounting boxes | yes |
| Nominal size for device installation units | R4 |
| Height-adjustment range, max. | 159 mm |
| Height-adjustment range, min. | 114 mm |
| Protection rating (IP) when used | IP20 |
| Protection rating (IP) when unused | IP44 |
| Protection rating IK code | IK10 |
| Heavy-duty version | yes |
| Heavy load class | 20 kN (OBO SL2) |
| Installation system type | UT3 |
| Floor covering thickness | 25 mm |