

# Technical data sheet

## Cross-over 60 FS

Item number: 6043623

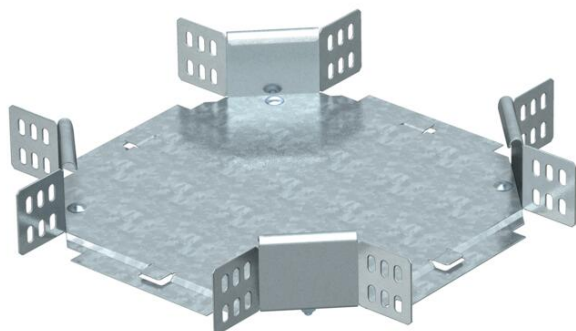

Horizontal cross-over for all cable tray types of 60 mm side height.  
The fitting is shipped in an unmounted state. All the sides are designed for the same cable tray width.  
Including appropriate fastening material.



**St** Steel

**FS** Strip galvanized

### Master data

Item number	6043623
Type	RK 620 FS
Description 1	Cross over
Description 2	horizontal + angle connector
Manufacturer	OBO
Dimension	60x200
Material	Steel
Surface	Strip galvanized
Surface standard	DIN EN 10346
Smallest sales unit	1
Unit of quantity	Piece
Weight	136.2 kg
Weight unit	kg/100 pc.

# Technical data sheet

## Cross-over 60 FS

Item number: 6043623



### Dimensions

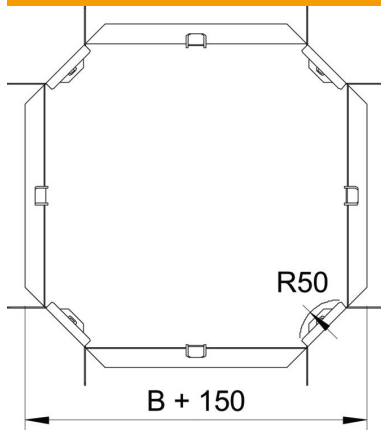

Width	200 mm
Width	8 in
Height	60 mm
Height	2 in
Dimension B	200 mm
Dimension R	50 mm

### Technical data

Bend (angle)	90°
Maintain electrical functions	no
Material thickness, floor plate	1 mm
Change of direction	Horizontal
Rustproof steel, pickled	no
Wide-span version	no
Type of connector, cable support system	Screwed
Rail thickness	1.25 mm