

Technical data sheet

Box cover

Item number: 2003244

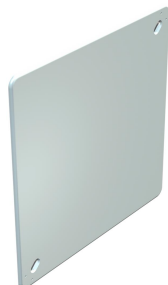

Box cover suitable for the connection sockets, type UV...K, cover edge is flush, surface is roughened, cover bolts can be lowered.



PS Polystyrene

Master data

Item number	2003244
Type	UV 100 D
Description 1	Box lid
Description 2	concealed
Manufacturer	OBO
Dimension	114x114x1,5
Colour	White
Material	Polystyrene
Smallest sales unit	10
Unit of quantity	Piece
Weight	2.004 kg
Weight unit	kg/100 pc.
CO2 Footprint (GWP) Cradle-to-Gate	0,0783 kg CO2e / 1 Piece

Technical data sheet

Box cover

Item number: 2003244



Dimensions

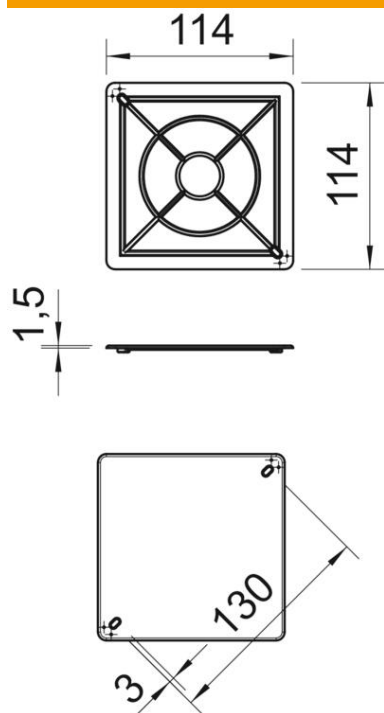

Length	114 mm
Width	114 mm
Height	1.5 mm
Dimension A	130 mm
Dimension B	114 mm
Dimension s	1.5 mm

Technical data

Fastening type	Screw-on lid
Flame-resistant	acc. to VDE 0471/DIN 695 Part 2-1, test temperature 650°C
Shape	Square
Halogen-free	yes
With bolts	no
Sealable	yes